

Optima® EAF-750 Faucet

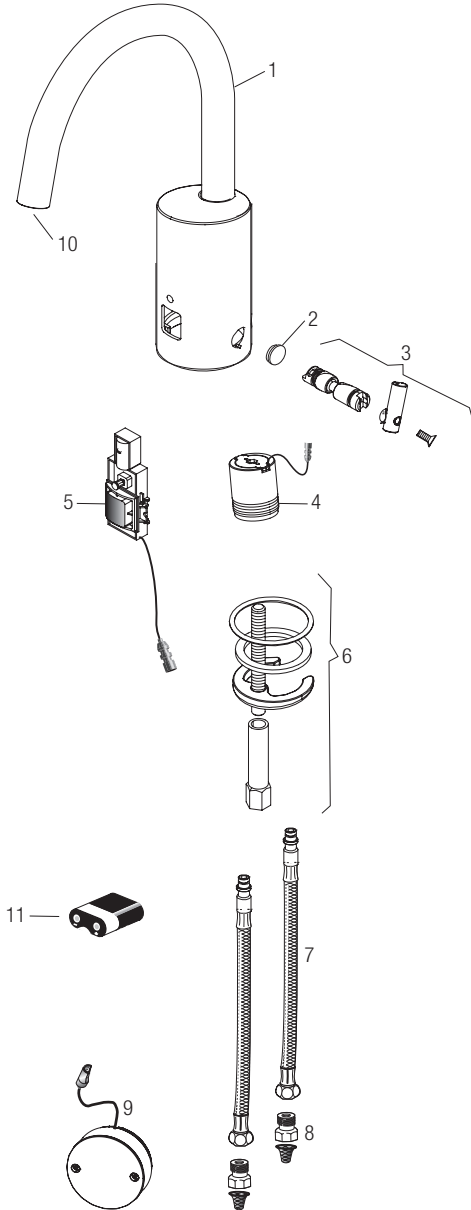

PARTS LIST—EAF-750 FAUCETS

Item			
No.	Code No.	Part No.	Description
1.	—	—	Spout Assembly
2.	3335022	EAF-1007	Integral Side Mixer Handle Cap
3.	3335019	EAF-1004	Integral Side Mixer Kit
4.	0335001	EAF-2	Solenoid
5.	3335099	EAF-1017-A	Sensor Assembly
6.	0335000	EAF-1	Mounting Hardware
7.	3335023	EAF-1008	13" (330 mm) Flexible Supply Hose (1)
8.	0335007	EAF-9	Filter/Strainer
9.	0335048	EAF-48	Battery Box
10.	3335086	EAF-1014-A	Multi-Lam Spray Head Kit 0.5 gpm (1.9 Lpm) Male Cache TJ
	3335087	EAF-1015-A	Spray Head Kit 1.5 gpm (5.7 Lpm) Aerated Male Cache TJ
	3335088	EAF-1016-A	Spray Head Kit 1.5 gpm (5.7 Lpm) Laminar Male Cache TJ
11.	3335018	EAF-1003	Battery Replacement Kit (CR-P2)



Optima® EAF-750 Faucet

OPERATION

As the user's hands enter the beam's effective range, the beam is reflected back into the sensor receiver and activates the solenoid valve allowing water to flow from the faucet. Water will flow until the hands of the user are removed or until the faucet reaches its automatic time out limit setting.

SET AND FIX TEMPERATURE (OPTIONAL)

Step 1

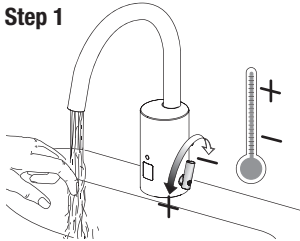

Step 3

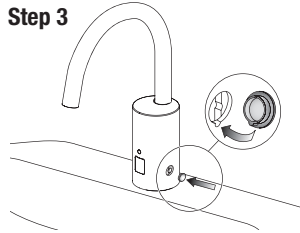

Step 2

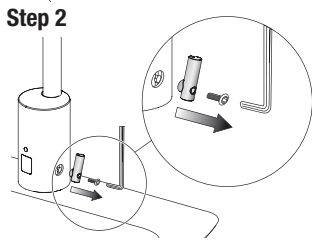

HOT LIMIT STOP ADJUSTMENT

Limit the maximum water temperature. Note: this does not take the place of an ASSE 1070 certified mixing device. But is an added measure to limit delivery of hot water.

Step 1

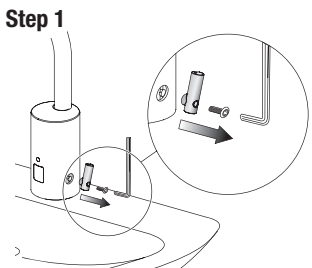

Step 4

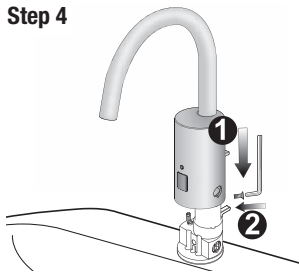

Step 2

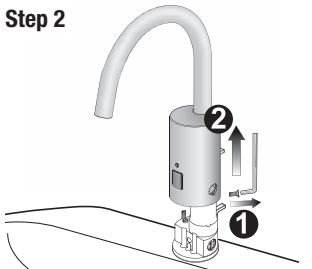

Step 5

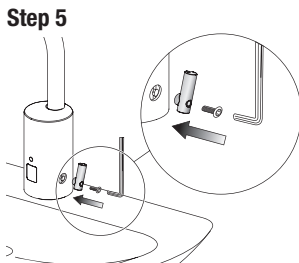

Step 3

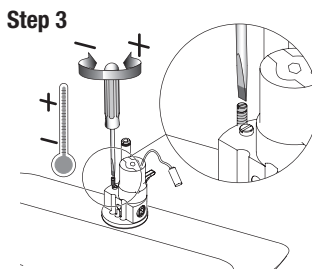

SENSOR RANGE ADJUSTMENT

Factory setting is appropriate for the majority of applications and should not require resetting unless under extreme situations.

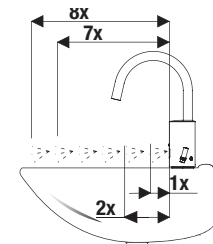

FACTORY DEFAULT = 6

Step 1

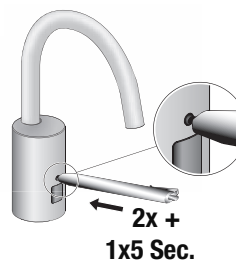

Step 4

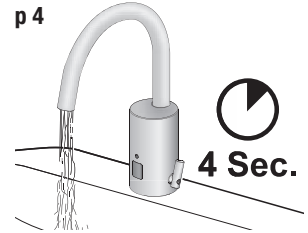

Step 2

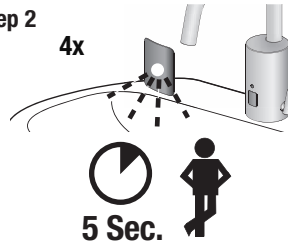

Step 5

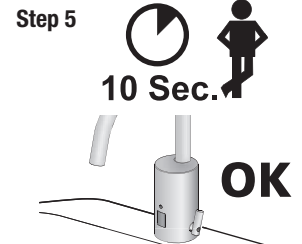

Step 3

1 x (1x, 2x,...,5x)

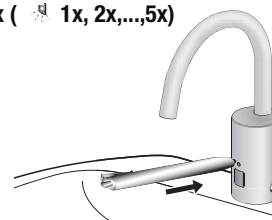

12/24 LINE PURGE FEATURE

This feature will operate the faucet every 12 or 24 hours since last use, if not used to prevent stagnant water conditions.

Default purge duration is two (2) minutes.

Consult factory regarding other timing options.

1x 24 sec

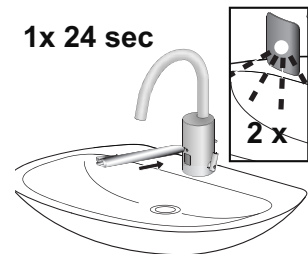

Optima® EAF-750 Faucet

I.Q.-CLICK FEATURE

1. CONTINUOUS RUN

Continuous run of water for two minutes.

Faucet will operate normally after two minutes or after pressing i.q.-click button once.

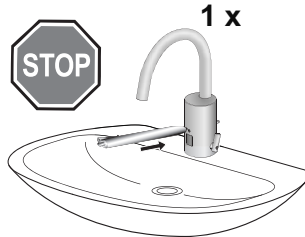
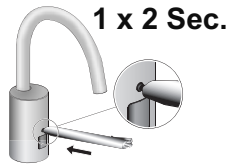

2. CLEANING MODE

Pause faucet for cleaning for two (2) minutes.

Faucet will operate normally after two (2) minutes or after pressing i.q.-click button once.

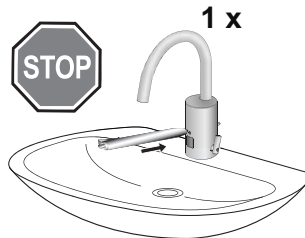
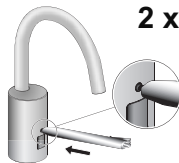

OFF-DELAY (FOLLOW UP TIME)

Duration of time the water runs after target is removed.

Press the button for approximately six (6) seconds. Release.

Press again (water flows) and release when the desired time of water flow (0-5 seconds) is reached.

Sensor will flash once and then the faucet is ready to operate.

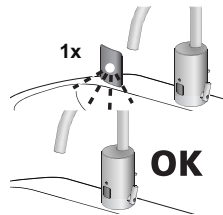

BATTERY REPLACEMENT

Note: Replace battery when red LED indicator flashes each time faucet is in use or when faucet stops functioning.

No need to turn off water.

Loosen screw with hex wrench and remove cap. Slide cover forward and lift off.

Remove battery.

Replace batteries with new "CR-P2" lithium battery (Sloan Kit# EAF-1003A).

Replace cover.

Activate faucet by pressing i.q. cliq one (1) time, then immediately step away.

Faucet will operate for four (4) seconds.

Wait 10 seconds and then the faucet is ready for operation.

