

Optima® EBF-825/ETF-820 Faucets

Parts & Accessories

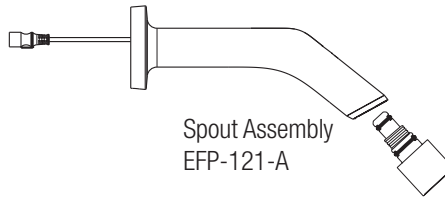

EBF-825 Wall mount, battery
ETF-820 Wall mount, hardwired



Spout Assembly
EFP-121-A

Spray Head
Carrier
EFP-1032-A



EBF-116-A

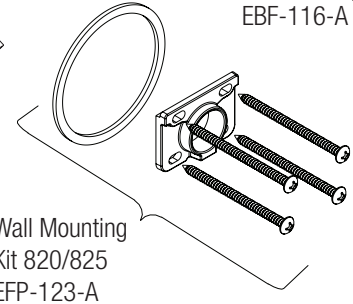

Wall Mounting
Kit 820/825
EFP-123-A

SPOUT ASSEMBLY

Description	Code No.	Part No.
Spout Assembly EBF-825 /ETF-820	03150015	EFP-121A
Sprayhead Carrier Assembly CP	0315265	EFP-1032A
Wall Mounting Kit 825/820	33620005	EFP-123A
Sensor and Cable Assembly	3315382	EFP-116A

SPRAYHEAD OPTIONS

Description	Type	Code No.	Part No.
0.35 GPM/1.3 Lpm	MLM	33620002	EFP-119
0.5 GPM/1.9 Lpm	MLM	33620001	EFP-120

BELOW DECK ASSEMBLIES

Description	Code No.	Part No.
Control Box No Turbine	0367039	EFP-39-A
Control Box Turbine 0.5 gpm	0367040	EFP-40-A
Control Box Turbine 1.5 gpm	0367011	EFP-11-A
Quick Connect Spout Hose 36"	0315322	EFP-1022
Control Box Cover w/Screw	0367010	EFP-10-A
Solenoid Assembly	0367103	EFP-103-A
Battery Pack	3324113	EFX-8-A
Double Inlet Tee Filter Assembly	0367028	EFP-28-A
BDM & Single Inlet Tee Filter Assembly Kit	0367099	EFP-99-A
BDT & Single Inlet Tee Filter Assembly Kit	0367100	EFP-100-A
Replacement Filter Pack-(5) Filter (5) Large O-rings (5) Small O-rings	0367101	EFP-101-A
24 VAC Power Harness Assembly	0367098	EFP-98-A
110V/6 VDC Power Supply	0362006	SFP-6
100-240 VAC/6 VDC Power Supply	0362016	SFP-36
120/24 VAC Power Supply	0365534PK	ETF-233
120/24 VAC Power Supply (Canada) Plug-in	0365879	ETF-416
120/24 VAC Power Supply (Box Mount)	0345370PK	EL-248-40
Extension Cable	0362017	SFP-37
Splitter Cable	0362018	SFP-38
Gang Adapter Kit	0362035	SFP-35-A
Faucet to Module Ext. Cable*	0367113	EFP-113-A



EFP-39-A
EFP-40-A
EFP-11-A

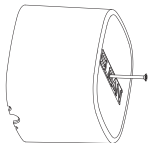

EFP-10-A
Cover and Screw ONLY



EFX-8-A



EFP-103-A

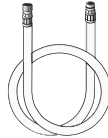

EFP-1022



SFP-6



SFP-36



SFP-37



SFP-38



EFP-98-A



EL-248-40



ETF-233



ETF-416

SFP-35-A

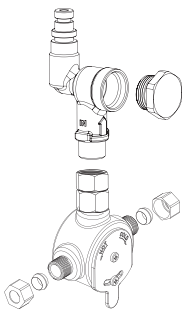

EFP-99-A

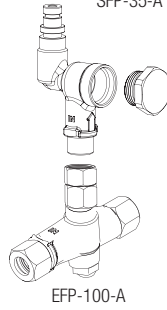

EFP-100-A

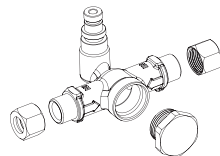

EFP-28-A



EFP-101-A

Optima® EBF-825/ETF-820 Faucets

Parts & Accessories

TROUBLESHOOTING INSTRUCTIONS FOR OPTIMA SENSOR ACTIVATED LAVATORY FAUCETS WITH THE NEW OPTIMA CONTROL BOXES AND THE SLOAN CONNECT SMARTPHONE APP.

NOTE: To automatically check battery strength, troubleshoot, diagnose and report faucet issues with a wireless device, use the Sloan SmartPhone APP. The APP is available free-of-charge at the Apple iPhone APP store for iOS devices or the Google Play APP store for Android devices. For more information about the APP and its capabilities please visit Sloan.com.

FAUCET TROUBLESHOOTING GUIDE

LED indicator light in the IR (infrared) sensor is red.

- A. Battery power is low.
Install four (4) new AA sized alkaline batteries. Check that the orientation of each battery matches the positive (+) and negative (-) symbols shown in the bottom of the battery compartment.
Re-attach battery compartment to control module. Green LED will illuminate. If the Green LED does not illuminate, remove battery compartment for 10 seconds and return into place.

Faucet DOES NOT function.

- A. Batteries not installed or are exhausted.
Install four (4) AA sized alkaline batteries. Check that the orientation of each battery matches the positive (+) and negative (-) symbols shown in the bottom of the battery compartment. Reattach battery compartment to control module. Green LED will illuminate. If the Green LED does not illuminate, remove battery compartment for 10 seconds and return into place.
- B. Power Cable not installed (Hardwire models).
Install power cable and check connection.
- C. Sensor Cable not installed.
Install sensor cable and check connection. Confirm connection guide markings are aligned.
- D. Sensor range is set too short and is not detecting the target.
Increase sensor detection range.

Sensor is activated but faucet DOES NOT deliver water.

- A. Faucet has initiated its adaptive sensing calibration program.
Wait 60 seconds before activating faucet.
- B. Solenoid Cable not connected.
Check solenoid cable connection. Confirm connection guide markings are aligned.

Sensor Range Requires Manual Adjustment.

Sensor Range is measured in units from 1 to 5, with 1 being closest to the faucet and 5 being farthest from the faucet. The factory default Sensor Range is 3.

- A. To determine what the current Sensor Range setting is, press the red "Sensor" button on the upper right hand corner of the Optima Control Box for 1 second. Five seconds after pressing the button, the green LED beside it will blink to indicate the Sensor Range setting. For example, if it is set at 2, the green LED will blink 2 times.
- B. To adjust the Sensor Range, press and hold the red "Sensor" button for three seconds and release once the green LED comes on to indicate that you are in Sensor Range adjustment mode. Then press the "Sensor" button one second at a time for however many times you wish to increase the range. For example, if the Sensor Range is set at 2 and you wish to increase it to 4, press the "Sensor" button two times for one second each time..
- C. If you wish to decrease the Sensor Range, follow the same procedure to enter into Sensor Range adjustment mode, and then press the "Sensor" button one second at a time. The button is designed to go up to 5 units and then back down to 1 unit. For example, if the Sensor Range is set at 4 and you wish to decrease it to 2, press the "Sensor" button three times for one second each time.
- D. To conform your changes, wait 5 seconds and then press the red "Sensor" button on the upper right hand corner of the Optima Control Box for 1 second. Five seconds after pressing the button, the green LED beside it will blink to indicate the Sensor Range setting. For example, if it is now set at 2, the green LED will blink 2 times.

Solenoid produces an audible "CLICK" when an object is placed in the detection zone of the sensor but NO water flows.

- A. Water supply to faucet is not open.
Open supply stop(s).
- B. Inlet fitting filter is clogged.
Remove, clean, and reinsert. Replace with EBF1004 solenoid filter kit if necessary.
- C. Aerator or spray head is clogged.
Remove, clean, and reinsert.

Optima® EBF-825/ETF-820 Faucets

Parts & Accessories

Solenoid valve DOES NOT produce an audible “CLICK” and NO water flows. Green LED illuminates when batteries installed.

- A. Solenoid valve module is not working properly.
Replace EFP103A solenoid valve module.

Faucet delivers only a slow flow or dribble when sensor is activated.

- A. Water supply valve is partially closed.
Open the supply stop(s) completely.
- B. Inlet fitting filter is clogged.
Remove, clean, and reinsert. Replace with EFP101A replacement filter kit if necessary.
- C. Aerator or spray head is clogged.
Remove, clean, and reinsert.

Faucet DOES NOT stop delivering water or continues to drip after user is no longer detected (automatic shut-off fails even when batteries are removed).

- A. Solenoid valve seat is dirty.
Remove, clean, and reinsert solenoid filter. Activate faucet several times to flush out dirt.
- B. Sensor range is set too long and is detecting the sink or some other object.
Reduce sensor detection range.
- C. Solenoid valve module is not working properly.
Replace EFP103A solenoid valve module.

The water temperature is too hot or too cold on a faucet connected to hot and cold supply lines with inlet filter fitting.

- A. Supply stops are not adjusted properly.
Adjust supply stops.

NOTE: For some systems, a thermostatic mixing valve may be required

SLOAN CONNECT APP FAQs

How do I connect my faucet to the Sloan mobile app?

To connect your faucet to the Sloan mobile App, you must complete the following steps:

1. Turn on your smartphone's Bluetooth.
2. Open the Sloan mobile app.
3. Complete all Sign In fields and agree to the End User License Agreement and Terms of Use.
4. Activate your faucets Bluetooth transmitter by slowly waving your hand underneath the faucet three (3) times within ten (10) seconds. Note: water will run during this process.
5. When your faucets Bluetooth transmitter is activated, the Sloan mobile app will display your faucet.
6. Select your faucet to confirm and connect to the Sloan mobile app.

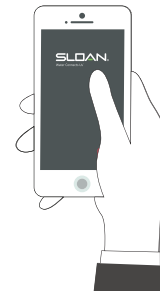

Can I still use my app and faucet if there is no internet connection?

Yes. The Sloan Connect App and faucet are designed to work in offline mode. All connectivity occurs via Bluetooth, which does not require an internet connection. If your phone is running Android 7, there is a built-in feature to prevent abusive BLE scanning. This change prevents an app from stopping and starting BLE scans more than 5 times in a window of 30 seconds. If this app does not detect any faucet and your phone is running Android 7, just exit the app and restart the app 30 seconds later.

My faucet is not showing in advertised devices.

Please be sure your Sloan Optima Control Box has power. To do this, remove the cover with the single screw in the center. Check there are no loose or disconnected wires and ensure the batteries are properly installed. Then repeat the connection process. If you are still experiencing issues, contact Sloan.

How do I save and load settings?

Each time you update settings on a faucet, they are stored in the app. If you would like to load the settings from a previous faucet to a new faucet, connect to that faucet and select the “Load Previous Settings”. This will display a dialogue box showing the previous settings. Click “Confirm” to load those settings into the app, then select “Apply Settings To Faucet” button at the bottom of your dashboard.

Why is the dashboard photo of my faucet not correct?

Each Sloan faucet type has several images associated with it. Use the left and right arrows to view the different faucet images.

How can I use the Sloan Connect App to save information about a specific faucet, like its location?

Select the “Notes” option from the main App screen and use this feature to include up to 120 characters worth of information.

When assistance is required, please contact Sloan Technical Support at:

1-888-SLOAN-14 (1-888-756-2614) (USA only) or +1-847-671-4300 (all other locations), or visit sloan.com