

CODE NUMBER

3362158IN

DESCRIPTION

4" Trim Plate, Plug Adapter Power Supply, Back-Check Tee, Polished Chrome Finish, 0.5 gpm, Multi-Laminar Spray, Infrared Sensor, Sloan® Hardwired-Powered Deck-Mounted Mid Body.

DETAILS

- Flow Rate: 0.5 gpm (1.9 Lpm) (0.5GPM)
- Spray Type: Multi-Laminar (MLM)
- Sensor Type: Infrared
- Mounting Type: Single Hole
- Trim Plate: 4" (102mm) (4)
- Power Supply: Plug Adapter (PLG)
- Temperature Mixer: Back-Check Tee (TEE)
- Finish: Polished Chrome (CP)
- Factory Default Timeout: 30 seconds
- Factory Default Gallons per Cycle: 0.25

FEATURES

Commercial Grade, ADA Compliant, Electronic, Sensor-Activated, Brass Pedestal Hand Washing Faucet with the following features:

- Adjustable Infrared Sensor Range
- 36" (914 mm) Long Sensor Cable
- 24" (610 mm) Long Flex Hose
- Filtered Solenoid Valve with serviceable Strainer Filter
- Includes Four (4) AA-size Batteries
- Includes appropriate Mounting Hardware

ELECTRICAL SPECIFICATIONS

- Battery Life: 2 years 8,000 cycles/month
- Sensor Range: 4" - 7" (102 - 178mm)
- Timeout Adjustment Settings: 30s

VIDEOS

- ▶ SF-2100/2150/SF-2200/2250/SF-2300/2350/SF-2400/2450 Parts Breakdown
- ▶ SF-2100/2150/SF-2200/2250/SF-2300/2350/SF-2400/2450 Module Replacement
- ▶ SF-2100/2150/SF-2200/2250/SF-2300/2350/SF-2400/2450 Battery Replacement- Sensor Range Adjustment

DOWNLOADS

- [SF Series Installation Instructions](#)
- [SF Series \(FR\) Installation Instructions](#)
- [SF Series \(SP\) Installation Instructions](#)
- [SFP 35-A Installation Instructions](#)
- [Trim Plate Guide](#)
- [Sloan 2400/2450 Repair and Maintenance Guide](#)
- [Additional Downloads](#)

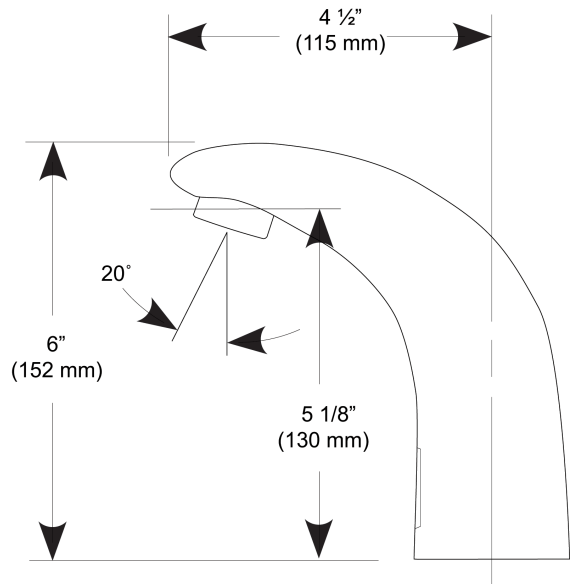

COMPLIANCES & CERTIFICATIONS

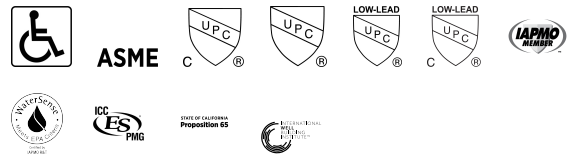

(ADA Compliant, ASME A112.18.1 Compliant, cUPC Certified, UPC Certified, UPC Low Lead Compliant, cUPC Low Lead Compliant, IAPMO, WaterSense Listed, NSF-61, Proposition 65, WELL Building Standard)

NOTES

All information contained within this document subject to change without notice.

Looking for other variations of the SF-2400 product? [View the general spec sheet with all options.](#)

[Find a matching soap dispenser](#) for this faucet.

[Find a compatible sink](#) for this faucet.

Sloan 10500 Seymour Ave, Franklin Park, IL 60131

Phone: 800.982.5839 • Fax: 800.447.8329 • sloan.com

WARRANTY

[View Warranty Information](#)

ROUGH-IN

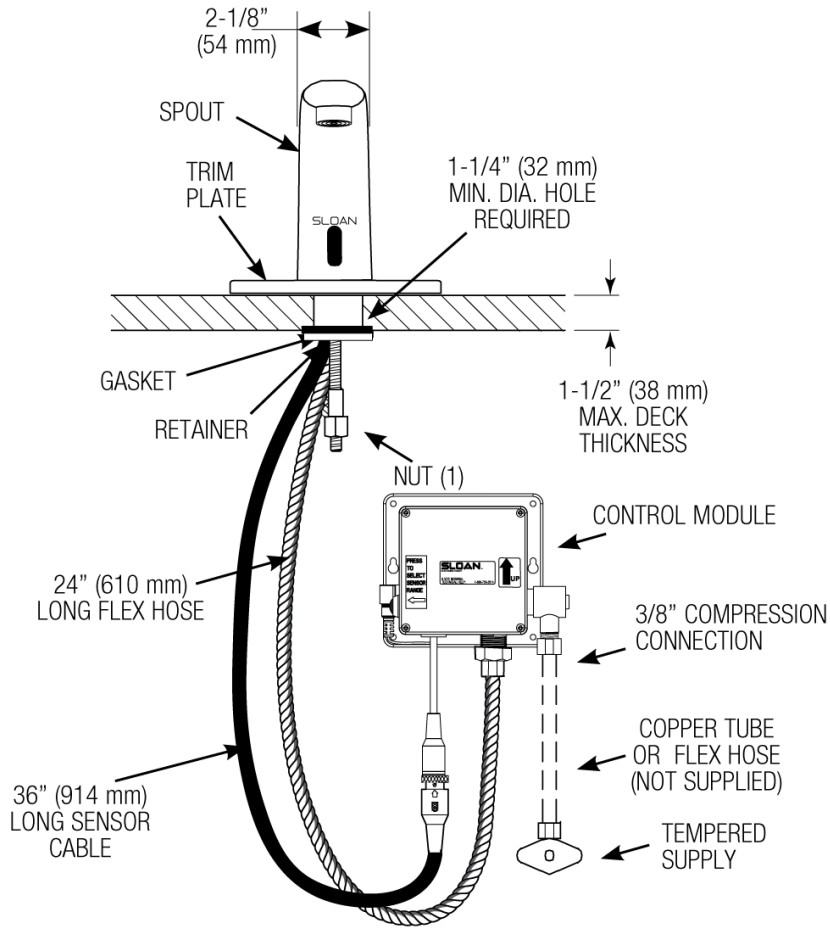

**HOT AND COLD WATER
SUPPLY APPLICATIONS**
(SPECIFY IN MODEL VARIATION)

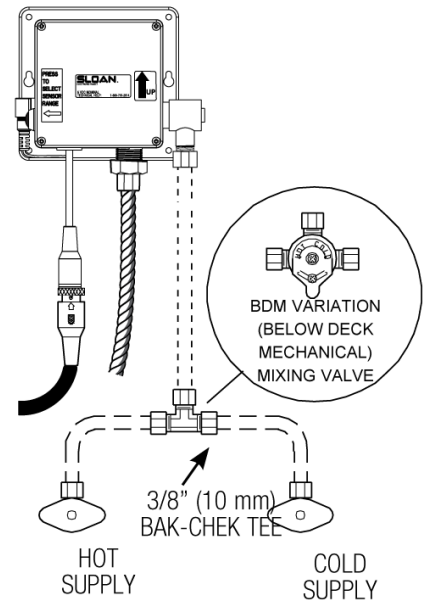

Sloan 10500 Seymour Ave, Franklin Park, IL 60131

Phone: 800.982.5839 • Fax: 800.447.8329 • sloan.com